

Forma 5

F25

Design by Tandem Company

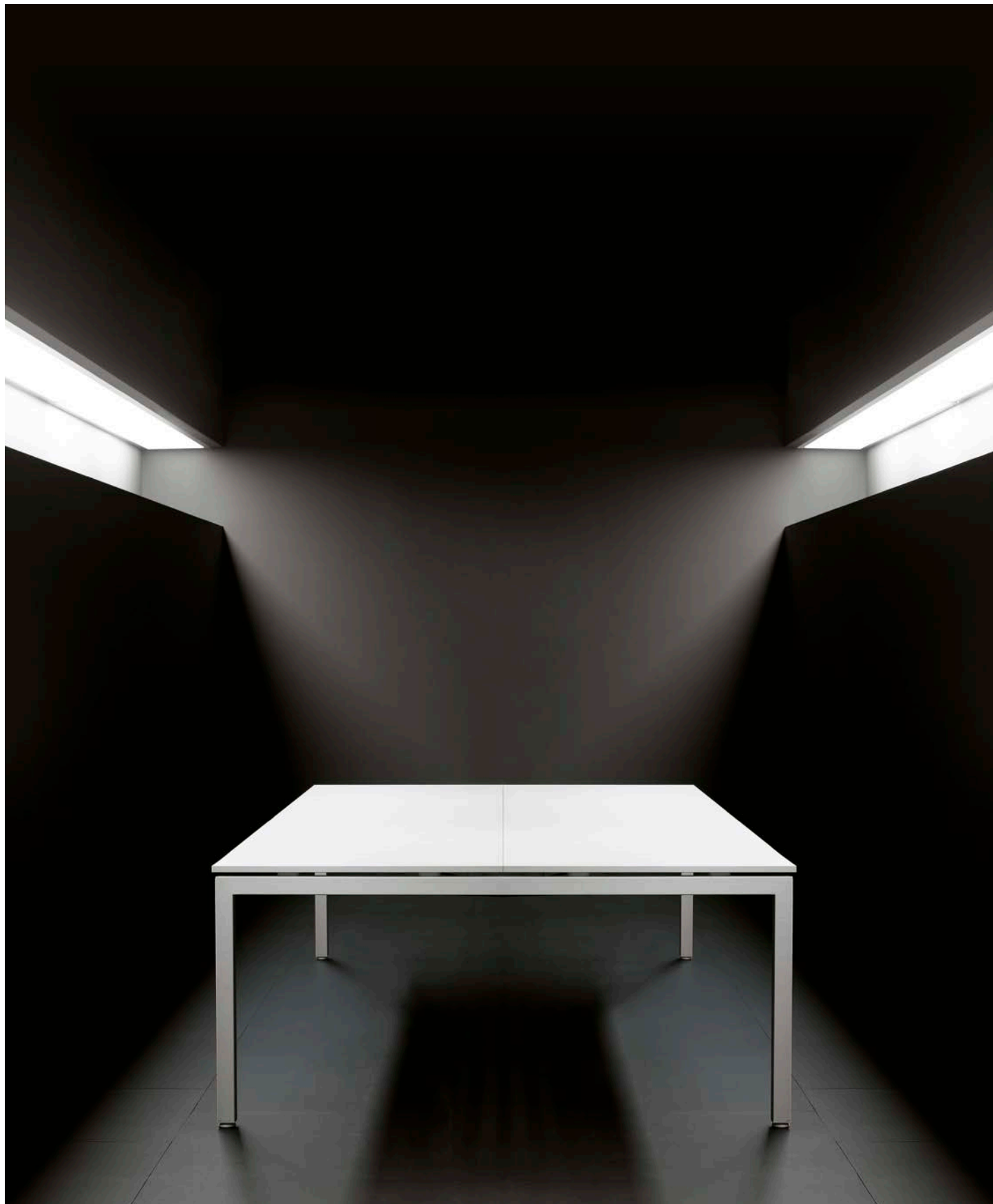

The F25 simple structure has provided solutions for entire companies; from private offices, team working, multistation departments and multi-use areas.

F25 es un programa de mobiliario compositivo que cuenta con una serie de accesorios adaptables a las tapas que permiten personalizar cada zona de trabajo según las necesidades del usuario.

F25 est une ligne de mobilier composite qui propose une série d'accessoires adaptables aux plateaux, permettant de personnaliser chaque zone de travail en fonction des besoins de l'utilisateur.



Within the options for the classic desks, there is the alternative to the table with wing for individual or double workstations. It is also possible to create new configurations as table tops that start from a low cabinet which acts as a "spine" for the system, from which the various workstations are set up, depending on the needs of each user.

Dentro de las opciones de mesas classic, existe la alternativa de mesa con ala para puestos singulares o puestos dobles. También es posible la configuración de mesas classic o bench en donde las tapas nacen desde un armario bajo que ejerce de "columna vertebral" del sistema, desde el cual se configuran los distintos puestos según las necesidades de cada usuario.

Dans les options du bureaux classic, il existe l'option d'une table à aile pour postes individuels ou postes doubles. Il est aussi possible les configuration ou des bureaux classic et bench où naissent le plateau de table qui part d'une armoire basse qui sert de "colonne vertébrale" du système, à partir duquel se configurent les différents postes suivant les nécessités de chaque utilisateur.

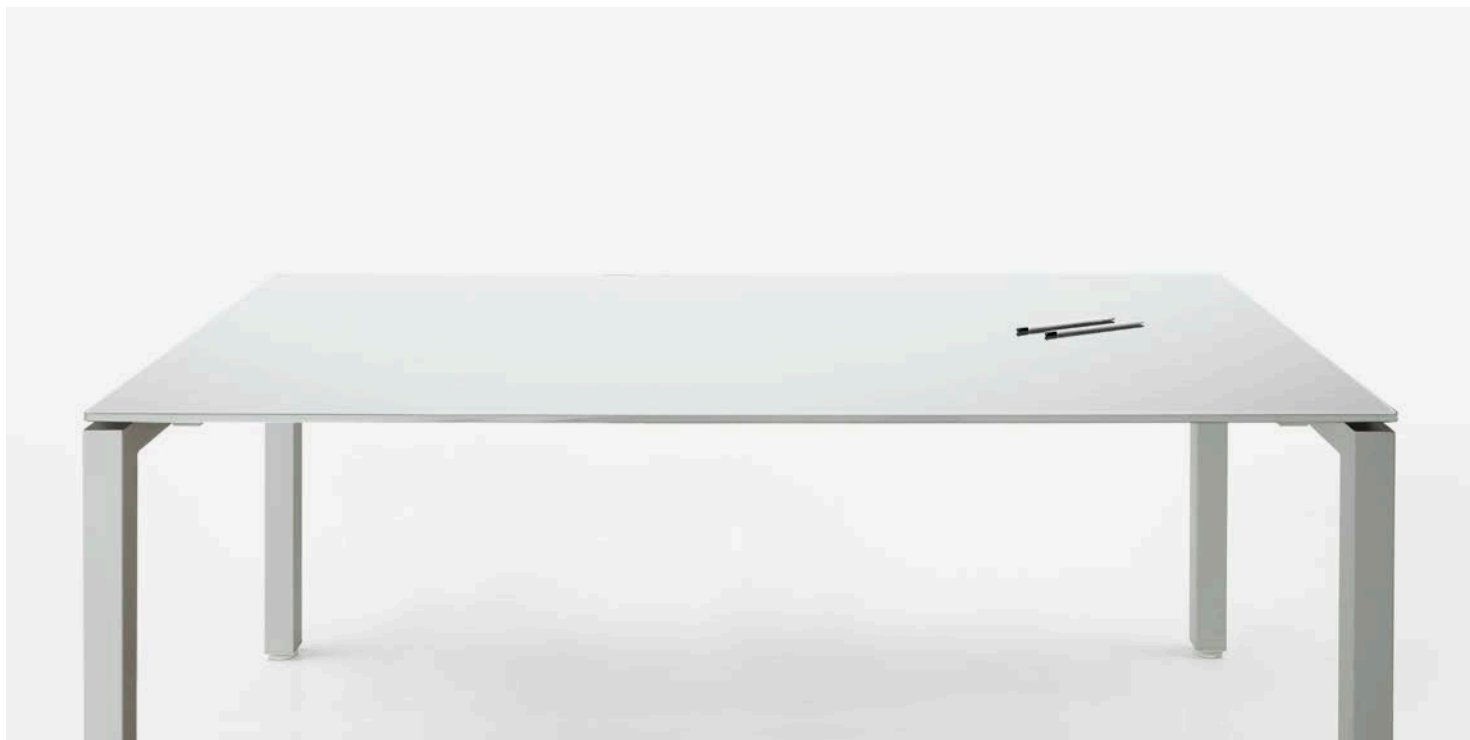



The photo shows how the tops can be supported by the support pedestal or on the lower cabinet, providing the work-station with a place for personal objects.

En la imagen se muestra cómo las tapas pueden apoyarse tanto sobre bucs como sobre armarios inferiores, aportando al puesto de trabajo un espacio para objetos personales

L'image montre comment les plateaux de table peuvent s'appuyer aussi bien sur des caissons que sur des armoires inférieures, offrant au poste de travail un espace pour les objets personnels



The photo shows how the tops rest on the legs and/or lower cabinets, creating a brighter and lighter look to the work-station.

En la imagen se muestra cómo las tapas se apoyan sobre pódicos y/o sobre armarios inferiores, creando un espacio más diáfano y ligero para el puesto de trabajo

L'image montre comment les plateaux de table s'appuient sur des portiques et/ou sur des armoires inférieures, en créant un espace plus ouvert et plus léger pour le poste de travail

We have followed the same line of thought from the start of when the idea formed: to design furniture that would integrate architecturally into the zone. We seek to create shapes that people will find useful and functional in their activities. In order to reflect this architecture, a study has to be made of the geometric proportion of bodies and the sensations they produce in us.

Una misma línea de ejecución nos persigue desde los comienzos de la idea: proyectar un mueble que se integre arquitectónicamente en el espacio. Buscamos plasmar las formas de tal modo que resulten útiles y funcionales para la actividad humana. Para representar esa arquitectura es preciso estudiar las proporciones geométricas de los cuerpos y las sensaciones que ellos nos producen.

Nous suivons toujours une même ligne d'exécution depuis le moment de la conception : projeter un meuble qui s'intègre architecturalement dans l'espace. Nous voulons traduire les formes de sorte qu'elles soient utiles et fonctionnelles pour l'activité humaine. Pour représenter cette architecture il faut absolument étudier les proportions géométriques des corps et les sensations qu'ils produisent en nous.



F25 allows furnishing each space of a modern office. The reception counter type configuration (simple or double) presents a double function: on the one hand, it is placed a working desk with a credenza that provides storage space in the lower part, while on the other hand, a high front with a top welcomes the visitor in the exterior part.

F25 permite amueblar cada espacio de una oficina moderna. La configuración tipo mostrador (simple o doble) presenta una doble función: por un lado, en la parte interior se plantea una mesa de trabajo junto con una credenza que da espacio de almacenamiento, mientras que por la parte frontal exterior un paravent alto junto con una tapa reciben al visitante para ser atendido.

F25 permet de meubler tous les espaces d'un bureau moderne. Les configurations disponibles pour les banques d'accueil (simple ou double) présentent une double fonction : d'une part, dans le zone derrière, il est placé un bureau de travail avec une crédence qui présente un espace de rangement dans la partie inférieure, tandis que, d'autre part, une paravent haute avec un petit plateau supérieur accueille le visiteur dans la partie frontale.



Projects

Due to the versatility of F25, this programme enjoys great success in projects which require tailored solutions for task furniture.

Proyectos

Dada la versatilidad de F25, la serie goza de gran éxito en proyectos donde requieren soluciones de amueblamiento operativo integral.

Projets

Dû à sa polyvalence, la série F25 connaît un grand succès dans les projets qui nécessitent des solutions d'aménagements complets et opérationnels.



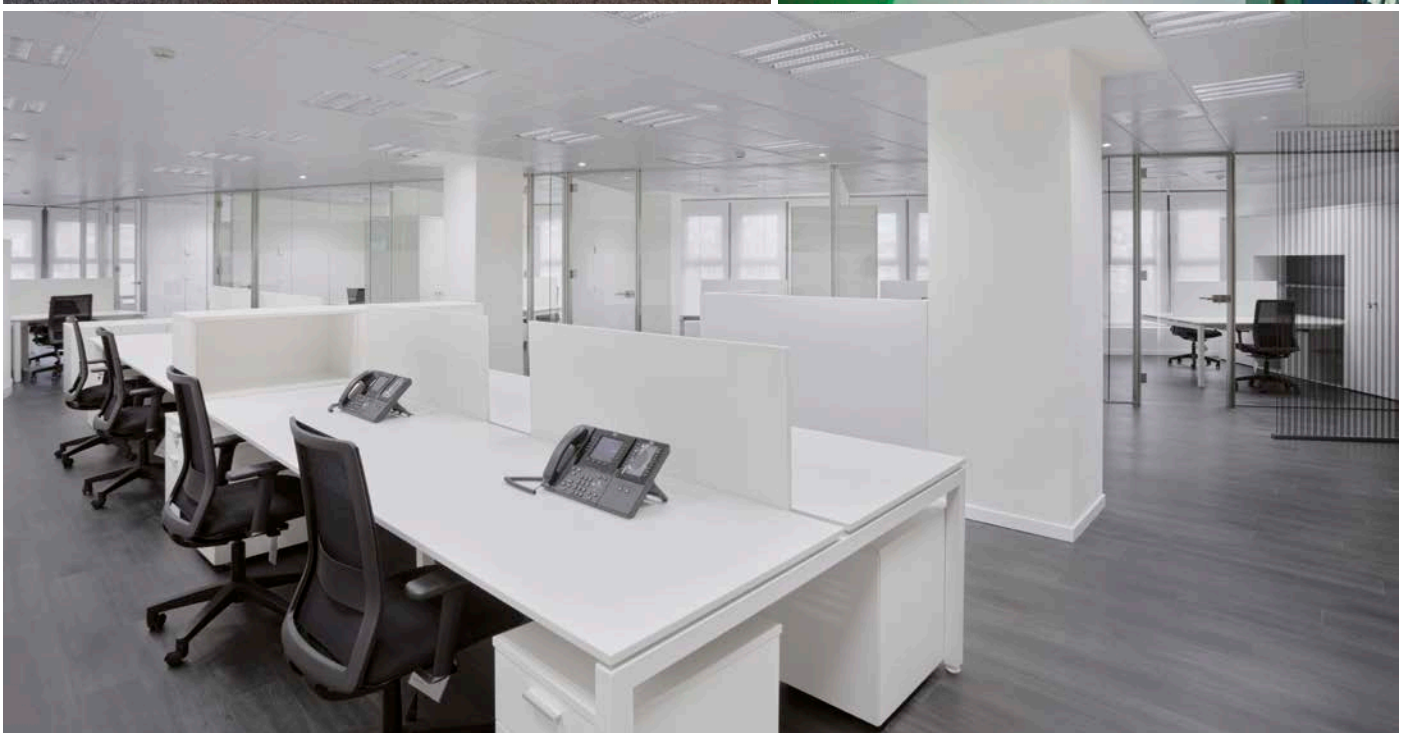
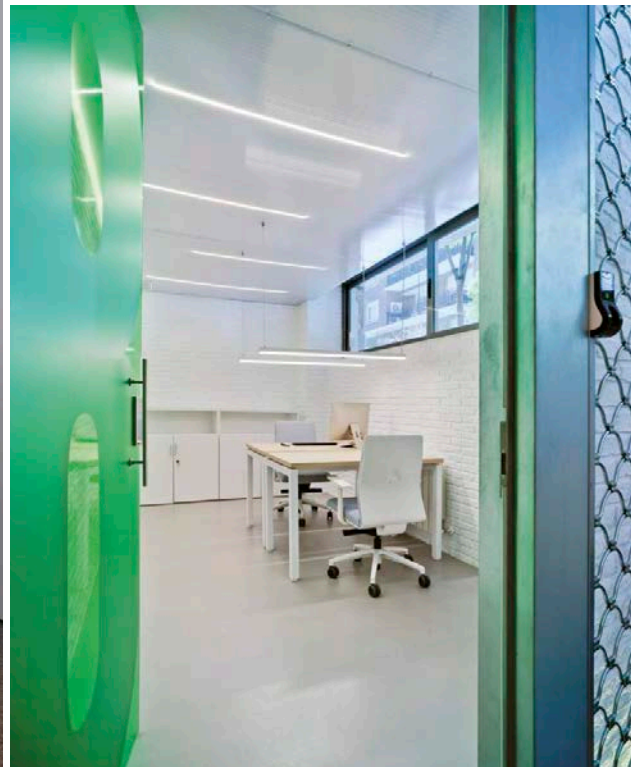





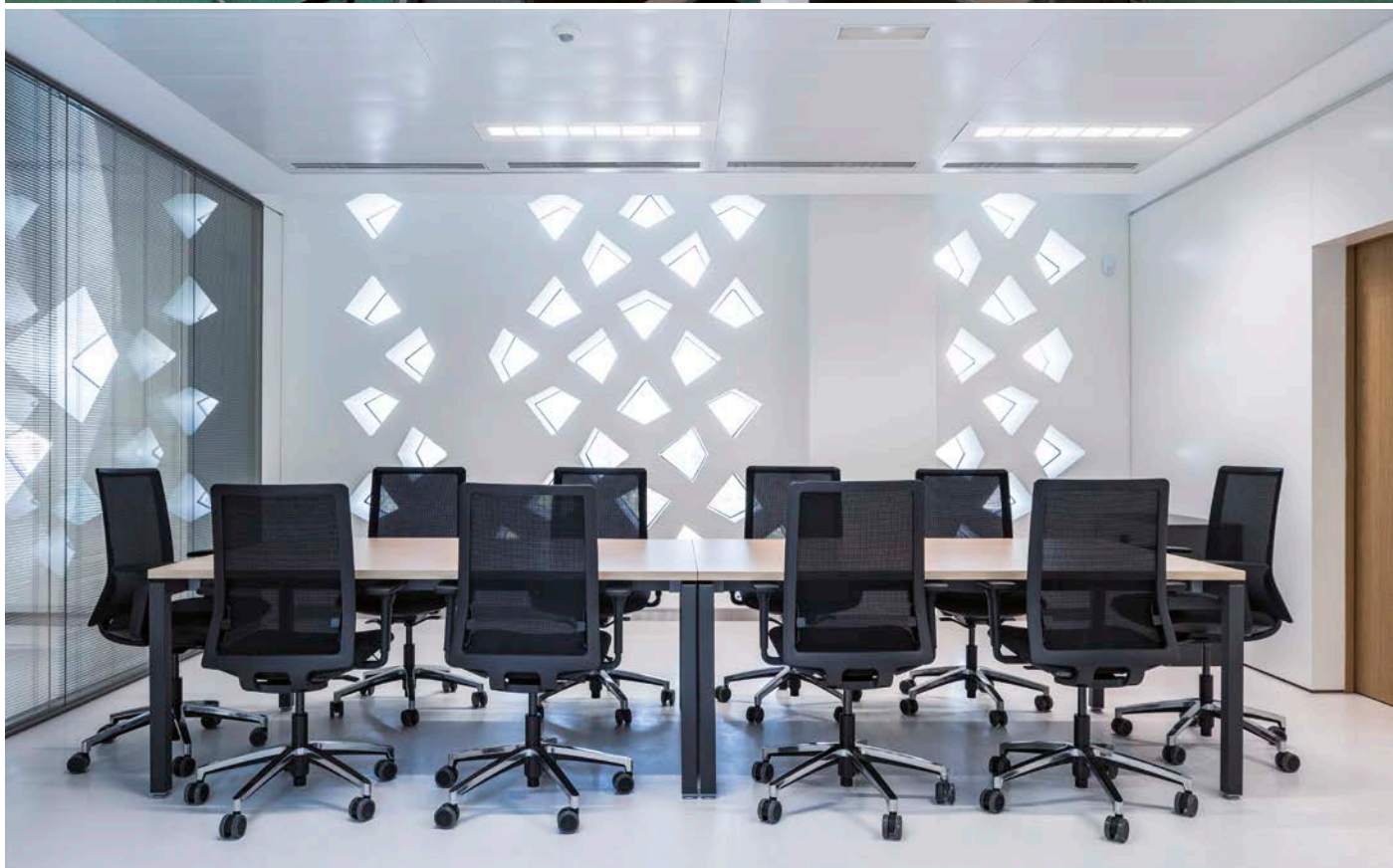
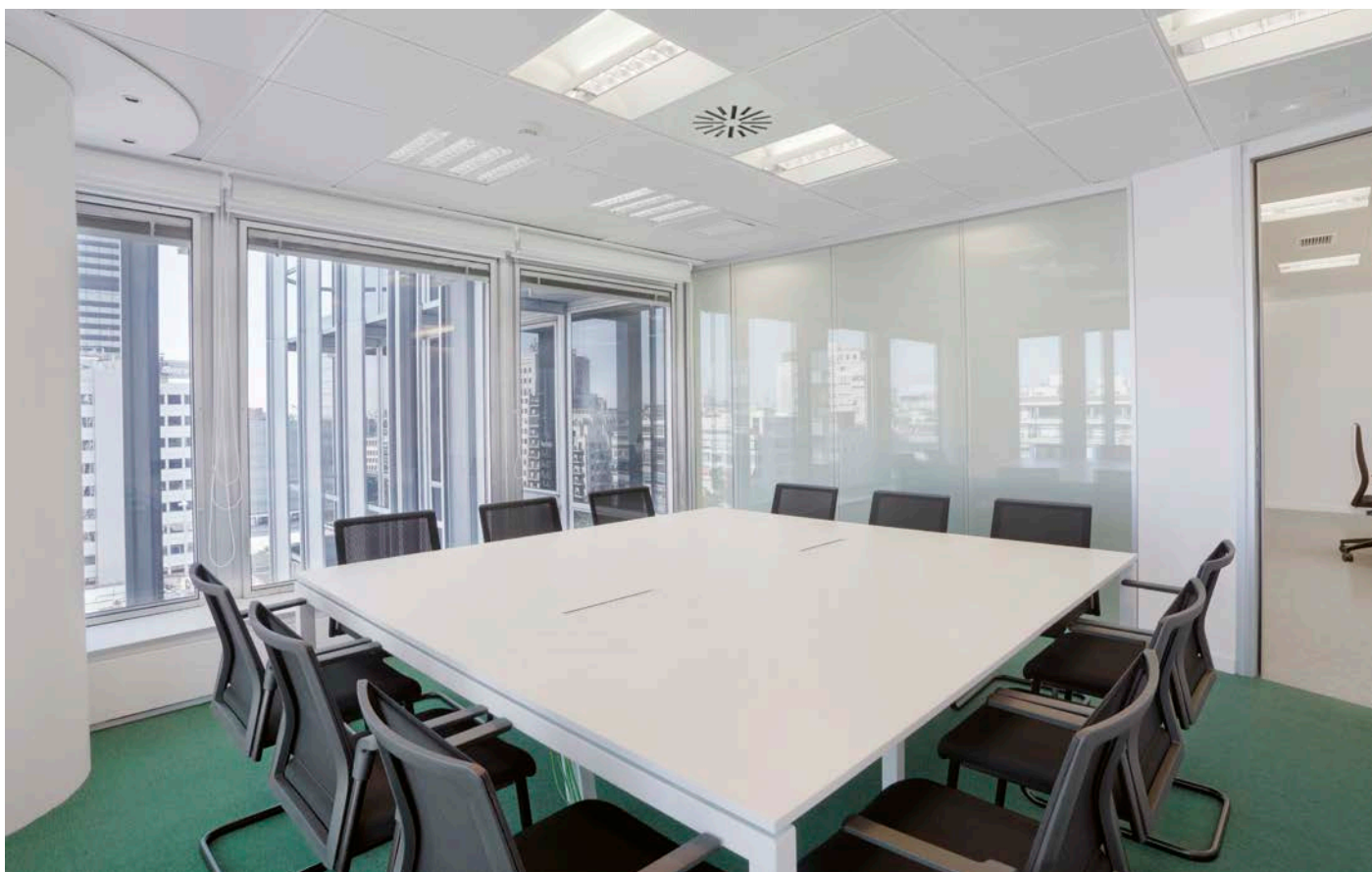

Special finish of structure / Acabado especial de estructura / Finition spéciale pour la structure

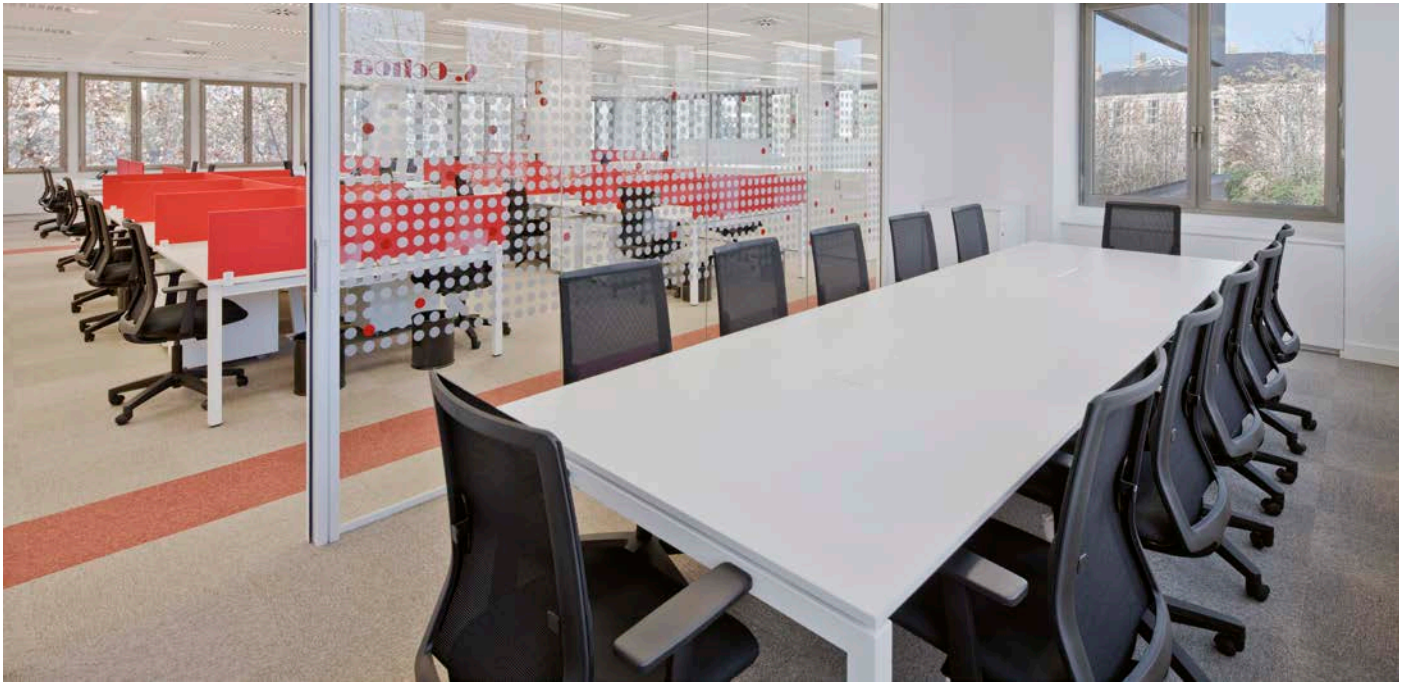

Top / Tapa / Plateau



- 19 or 30 mm melamine top
- Tapa bilaminada 19 ó 30 mm
- Plateau mélaminé 19 ou 30 mm



- 10 mm hardened glass top
- Tapa vidrio 10 mm
- Plateau en verre 10 mm

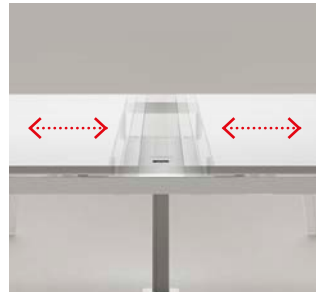

- Sliding top for cable management
- Tapa deslizante para electrificación
- Glissement de plateau pour l'électrification

Pedestal / Pedestal / Piètement

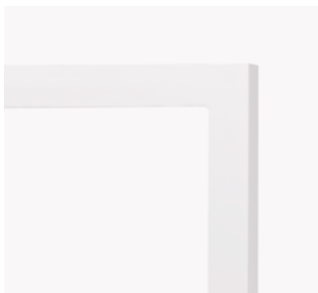

- Leg frame (polar white)
- Pórtico (blanco polar)
- Portique (blanc polaire)

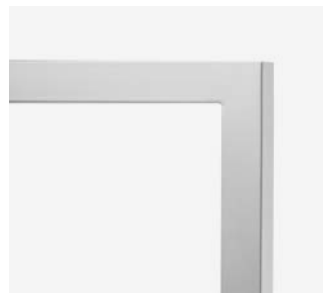

- Leg frame (silver grey)
- Pórtico (gris plata)
- Portique (gris argent)



- Height adjustment leg frame
- Pórtico con regulación en altura
- Portique avec régulation en hauteur

Screens / Separadores / Écrans

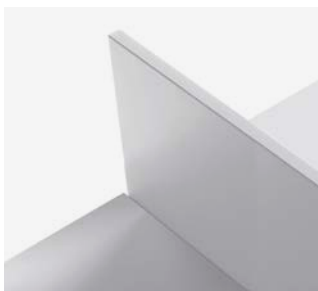

- Melamine or upholstered screen
- Separador bilaminado o tapizado
- Écran mélaminé ou tapissé



- 3+3 mm laminated glass with butyral
- Separador de vidrio laminado de 3+3 mm con butiral
- Écran en verre laminé de 3+3 mm avec butiral



- Upholstered desk screen
- Separador tapizado
- Écran tapissé



- Technical screen
- Separador técnico
- Écran technique

Modesty panel / Faldón / Voile de fond



- Melamine modesty panel
- Faldón bilaminado
- Voile de fond mélaminé



- Metallic modesty panel
- Faldón metálico
- Voile de fond métallique

Top access



- Aluminium top access
- Top access aluminio
- Top access en aluminium



- Polyamide top access
- Top access poliamida
- Top access en polyamide

Cable management / Electrificación / Électrification



- Metal cable pillar
- Columna metálica de cableado
- Colonne métallique d'électrification



- Adjustable CPU cabinet: height and width
- Porta CPU regulable en anchura y altura
- Porteur PC réglable en hauteur et largeur



- Simple tray 100 cm
- Bandeja simple 100 cm
- Support pour câbles simple 100 cm



- Double trays 120 or 100 cm
- Bandeja doble 120 ó 100 cm
- Support double pour câbles 120 ou 100 cm

Pedestals / Bucs / Caissons



- Mobile pedestal
- Buc rodante
- Caisson mobile



- 43 cm width support pedestal
- Buc pedestal ancho 43 cm
- Caisson porteur largeur 43 cm

Overviews / Configuraciones y dimensiones / Configurations et dimensions

Desk and add-on desks
Mesas individuales y crecimientos
Bureaux individuels et croissances

A x B 180 x 80 180 x 67 162 x 80 160 x 67 160 x 80 140 x 67 140 x 80 136 x 67 120 x 80 120 x 67	A x B 180 x 80 160 x 80 140 x 80	A x B 180 x 80 140 x 80 160 x 80 120 x 80	A x B 180 x 80 180 x 67 160 x 80 160 x 67 140 x 80 140 x 67 120 x 80 120 x 67	A x B 180 x 80 140 x 80 160 x 80 120 x 80
---	--	--	--	--

Return desks
Alas
Retours

Glass desks
Mesas de cristal
Bureaux en verre

A x B 180 x 80 160 x 80 140 x 80	A x B 180 x 80 140 x 80 160 x 80 120 x 80	A x B 100 x 56 80 x 56	A x B 100 x 56 80 x 56	A x B 180 x 80 160 x 80
--	--	-------------------------------------	-------------------------------------	--------------------------------------

Bench desks and add-on desks
Bench y crecimientos
Bench et croissances

A x B/b1 180 x 162,4/80 180 x 136,4/67 160 x 162,4/80 160 x 136,4/67 140 x 162,4/80 140 x 136,4/67 120 x 162,4/80 120 x 136,4/67	A x B/b1 180 x 162,4/80 160 x 162,4/80 140 x 162,4/80	A x B/b1 180 x 162,4/80 160 x 162,4/80 140 x 162,4/80 120 x 162,4/80	A x B/b1 180 x 162,4/80 180 x 136,4/67 160 x 162,4/80 160 x 136,4/67 140 x 162,4/80 140 x 136,4/67 120 x 162,4/80 120 x 136,4/67
A x B/b1 180 x 162,4/80 160 x 162,4/80 140 x 162,4/80	A x B/b1 180 x 162,4/80 160 x 162,4/80 140 x 162,4/80 120 x 162,4/80		

Compact desks
Mesas compactas
Bureaux compacts

A/a1 x B/b1 180/80 x 180/56 160/80 x 180/56 180/80 x 160/56 160/80 x 160/56	A/a1/a2 x B/b1 360/180/80 x 180/56 360/180/80 x 160/56 320/160/80 x 180/56 320/160/80 x 160/56	A/a1 x B/b1/b2 180/80 x 362/180/56 180/80 x 322/160/56 160/80 x 362/180/56 160/80 x 322/160/56	A/a1/a2 x B/b1/b2 360/180/80 x 362/180/56 360/180/80 x 322/160/56 320/160/80 x 362/180/56 320/160/80 x 322/160/56
--	---	---	--

Overviews / Configuraciones y dimensiones / Configurations et dimensions

Configurations with cabinets
Composiciones con armarios
Compositions avec armoires

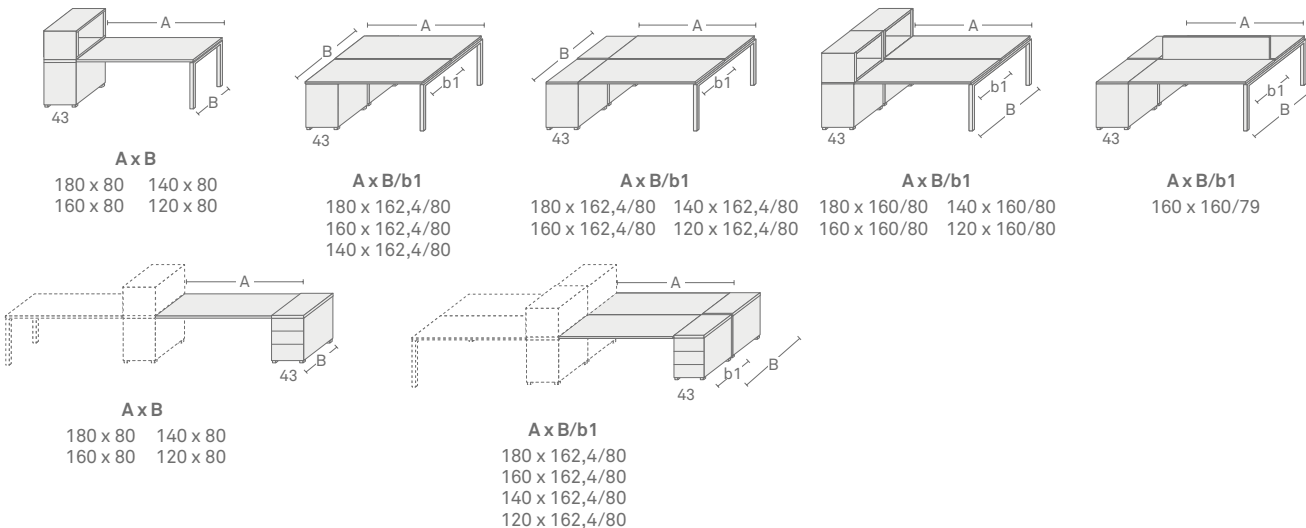

Configurations with Axis cabinets
Composiciones con armarios Axis
Compositions avec armoires Axis

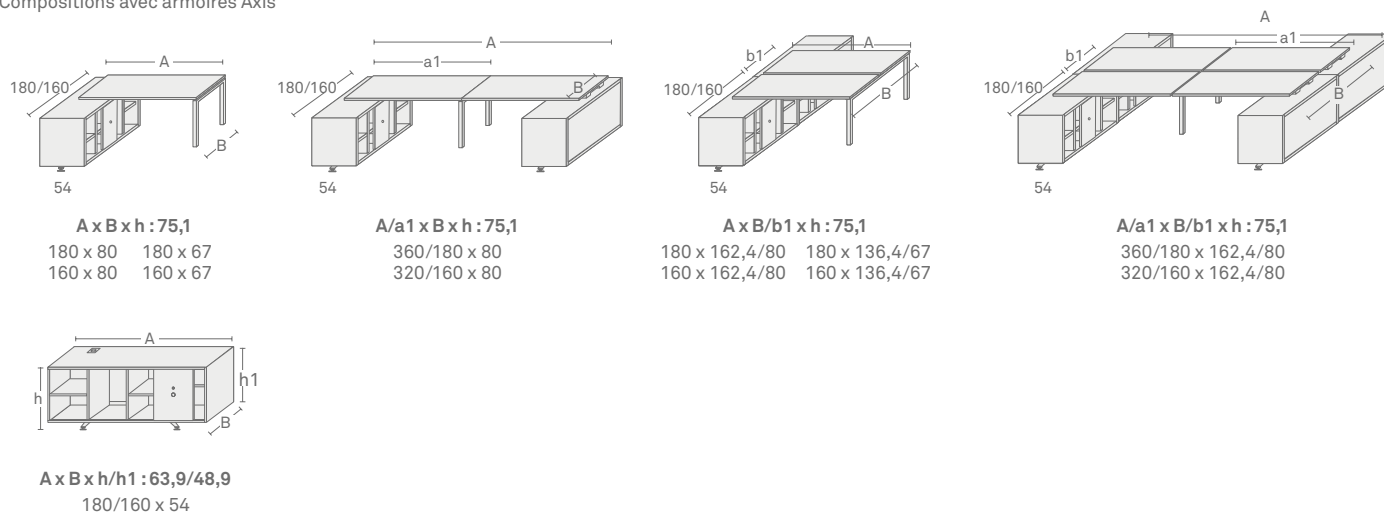

Meeting tables
Mesas de reunión
Tables de réunion

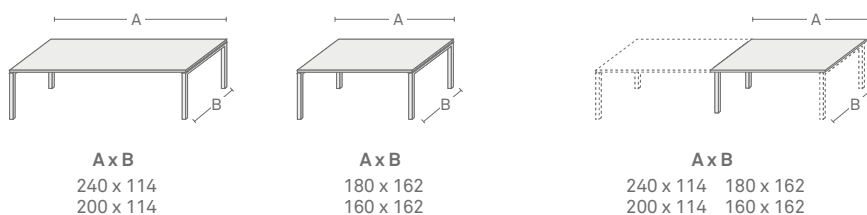

Desks height: 74 cm (19 mm melamine tops), 75,1 cm (30 mm melamine tops) and 73,1 cm (glass tops).
Altura mesas: 74 cm (tapas de melamina 19 mm), 75,1 cm (tapas de melamina 30 mm) y 73,1 cm (tapas de vidrio).
Hauteur tables: 74 cm (plateaux de mélamine 19 mm), 75,1 cm (plateaux de mélamine 30 mm) et 73,1 cm (plateaux en verre).

Overviews / Configuraciones y dimensiones / Configurations et dimensions

Reception counters
Mostradores
Banques d'accueil

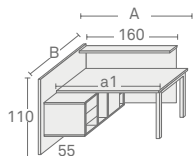

A/a1 x B/b1 x h : 74
183/180 x 170/80

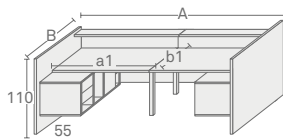

A/a1 x B/b1 x h : 74
325/162,5 x 170/80

Cabinets for desks
Armarios para mesas
Armoires pour bureaux

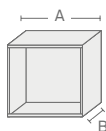

Low cupboard without doors
Armario inferior diáfano
Armoire inférieure sans portes

A x B x h : 72
80 x 43

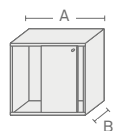

Low cupboard with sliding doors
Armario inferior con puerta corredera
Armoire inférieure avec portes coulissantes

A x B x h : 72
80 x 43

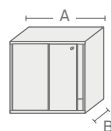

Low cupboard with 2 sliding doors
Armario inferior con 2 puertas correderas
Armoire inférieure avec 2 portes coulissantes

A x B x h : 72
80 x 43

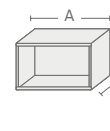

Upper cupboard without doors
Armario superior diáfano
Armoire supérieure sans portes

A x B x h : 42
80 x 43

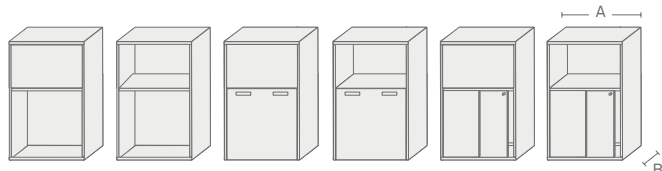

A x B x h : 112,1
80 x 43,5

Designers / Diseñadores / Designers

Tandem Company

Experts in the process of innovation, design and development of products. Their work, together with the customer's knowledge and experience, provides a different point of view, generating new ideas resulting in successful products. In addition, Tandem works in a dedicated and efficient way with companies from several sectors, such as: Holding Simon (Simon, Simon Tech, Simon Lighting, E2S), Mitsubishi Electric, Diset, Araven, Lucta among others.

Expertos en el proceso de innovación, diseño y desarrollo de productos. Su trabajo, unido al conocimiento y experiencia del cliente, posibilita un punto de vista diferente, generando nuevas ideas que desemboquen en productos de éxito. Además, Tandem colabora de una manera comprometida y eficaz con empresas de diferentes sectores como: Holding Simon (Simon, Simon Tech, Simon Lighting, E2S), Mitsubishi Electric, Diset, Araven, Lucta entre otras.

Expert dans le processus d'innovation, de design et de développement des produits. Le travail, uni à la connaissance et à l'expérience du client, permet d'avoir un point de vue différent, ce qui donne lieu à des nouvelles idées qui débouchent sur des produits de succès. D'autre part, Tandem collabore d'une manière engagée et efficace avec des entreprises de différents secteurs, comme par exemple : Holding Simon (Simon, Simon Tech, Simon Lighting, E2S), Mitsubishi Electric, Diset, Araven, Lucta entre autres.